

You Are Always Our VIP !

---

# Public Address Amplifiers User Manual

(3U High Power Series)

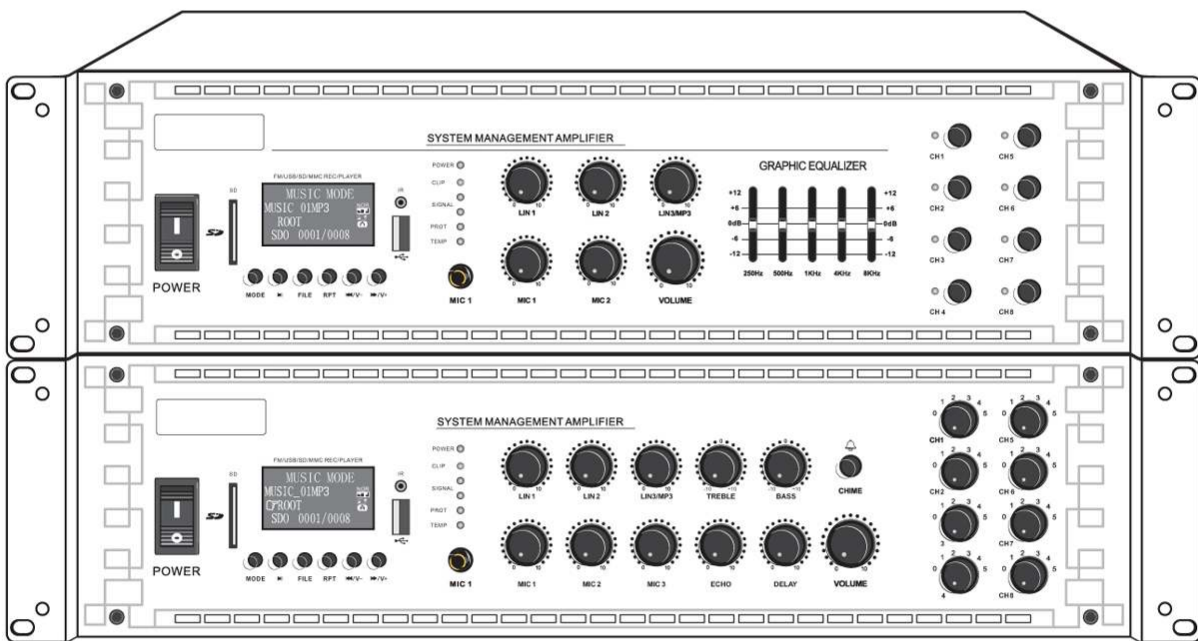

[info@vipsounds.com](mailto:info@vipsounds.com)

## SAFETY NOTICES AND CAUTIONS



The lightning flash with arrowhead symbol within an equilateral triangle is intended to alert the user to the presence of uninsulated “dangerous voltage” within the product’s enclosure that may be of sufficient magnitude to constitute a risk of electric shock to persons. The exclamation point within an equilateral triangle is intended to alert the user to the presence of important operating and maintenance (servicing) instructions in the literature accompanying the product.

- ❗ Read this manual carefully before using this product for the first time. This manual includes important instructions about installation, operation and safety precautions.
- ❗ We will assume no responsibility if you do not comply with these instructions and meet troubles.
- ❗ The output voltage can reach up to 180 volts, all installations and operations must be referred to qualified personnel who has been specially trained.
- ❗ Not suitable for household.
- ❗ Do not remove the ground terminal of the power cord.

### 1. Location

Keep the unit away from locations where it is likely to be exposed to high temperatures or humidity—such as near radiators, etc. Also avoid locations which are subject to excessive dust accumulation or vibration which could cause mechanical damage and locations subject to strong electromagnetic fields, such as close to broadcast equipment.

### 2. Ventilation

The unit has ventilation slots on the side and bottom panels. Do not block these vents.

### 3. Avoid physical shocks

Strong physical shocks to the unit can cause damage. Handle it with care.

### 4. Do not open the case or attempt repairs or modifications yourself

This product contains no user-serviceable parts. Refer all repair or maintenance to qualified engineer.

## CONTENTS/FEATURES

### 5. Always power off before making connections

Always turn the power off before connecting or disconnecting cables. This is important to prevent damage to the unit itself as well as other connected equipment.

### 6. Clean with a soft dry cloth

Never use solvents such as Benzine or thinner to clean the unit.  
Wipe clean with a soft, dry cloth.

### 7. Always use the correct power supply

Make sure that the power supply voltage specified on the rear panel matches your local AC mains supply. Also make sure that the AC mains supply can deliver more than enough current to handle all equipment used in your system.

### 8. Must be connected correctly

Although this unit have goodly protect functions to avoid damage because of short or overload, we should be turn away short or overload for system chronically turning normally.

## CONTENTS

SAFETY NOTICES AND CAUTIONS .....	1
CONTENTS/FEATURES .....	2
THE FRONT PANEL & REAR PANEL .....	3/4/5
INSTALLATIONS AND OPERATIONS .....	6
CONNECTIONS .....	7/8
TECHNICAL SPECIFICATIONS .....	9

**We reserve the right to make any improvements to these products without notice.**

## FEATURES:

1. Two microphone input, and MIC 1 has the priority mute function.
2. Three stereo line inputs for connecting various audio sources such as CDs, radios, tape players, and etc.
3. The level of the microphone or line can be adjusted individually.
4. Equipped with a treble and bass equalizer, output level control and ringer generator.
5. The unit provides a line output for recording or connecting to other amplifiers.
6. Three types of output terminals: 4-16  $\Omega$ ; 70 V; 100 V.
7. Output power can be distributed to 8 zones.
8. Output level indicator, built-in Bluetooth compatibility, FM radio player, USB and SD card.
9. Overload distortion when 5 LEDs are on long. The volume knob should be adjusted so that the 3rd-4th LEDs are blinking.
10. Configured with a 5-band equalizer. ( for HZ-EQ series only)
11. Configured with 4.3 inch LCD touch screen. (for HZ-IP series only)
12. Microphone reverb repeat count and delay control are adjustable. ( for HZ-ECHO series only )

# THE FRONT PANEL & REAR PANEL

## The Front Panel

### HZ-EQB Series Front Panel

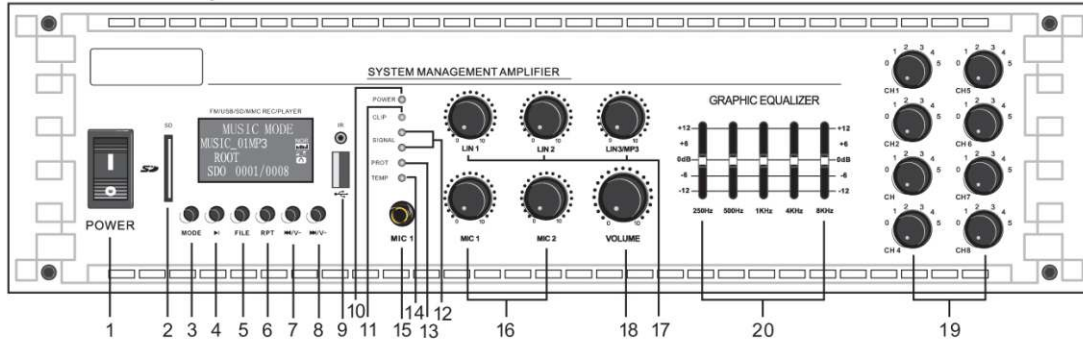

### HZ-EQP Series Front Panel

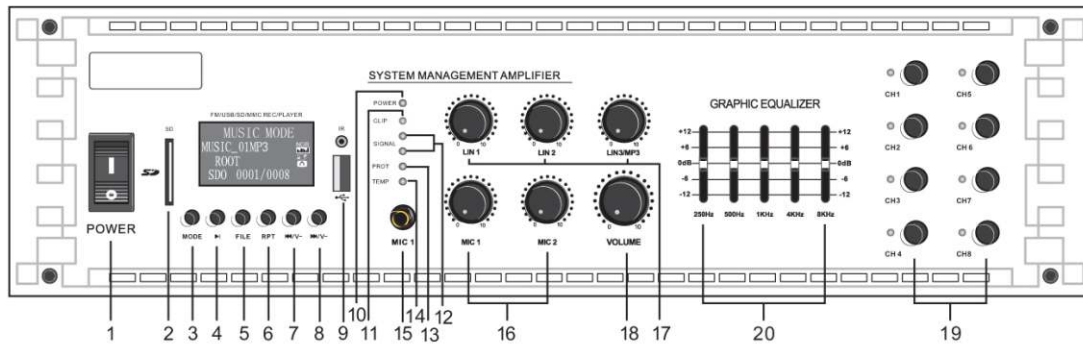

### HZ-ECHOB Series Front Panel

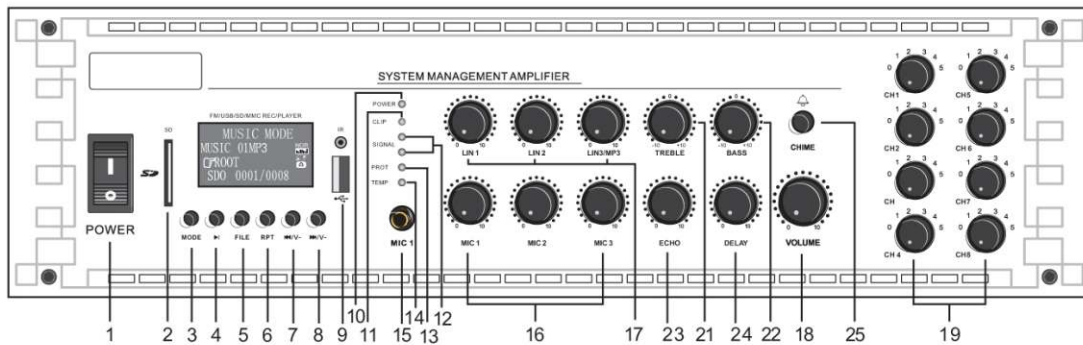

### HZ-ECHOP Series Front Panel

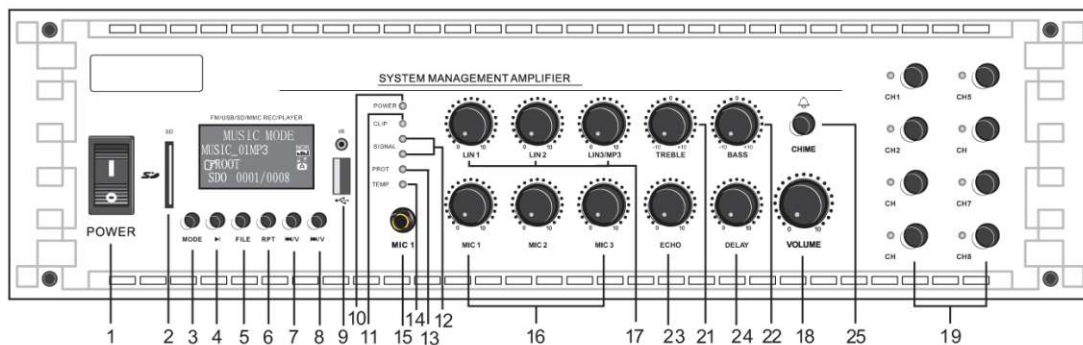



## THE FRONT PANEL & REAR PANEL

1. Power On/Off
2. SD Card Slot
3. Mode  
Used to select the operating mode of the device, the operating mode cycles in the order of "FM AUX MP3 Bluetooth".
4. Play and Pause  
Short press this button to get the next stored radio station, and long press it to search and store stations automatically.
5. File/Folder
6. RPT/Repeat
7. V-  
Short press this button to go to the previous song, long press this button to lower the volume. In FM mode, press this key briefly to search for stations from high to low.
8. V+  
Short press this button to go to the next song, long press this button to higher the volume. In FM mode, press this key briefly to search for stations from low to high.
9. USB
10. Power Indicator
11. Clip
12. Output Level Indicator
13. Short Circuit Indicator/Overload Indicator
14. High Temperature Indicator
15. MIC 1 Input  
This Microphone has the priority mute function
16. Buttons for Adjusting the Microphone Input Level
17. Buttons for Adjusting the Line and MP3 Input Level
18. Volume Final Output Adjustment
19. Individual Adjustment of Each Partition
20. Five-band Graphic Equalizer
21. Treble Adjustment
22. Bass Adjustment
23. ECHO Button
24. Delay Button  
Button for adjusting the microphone reverb delay time.
25. CHIME Button

## THE FRONT PANEL & REAR PANEL

### Rear Panel

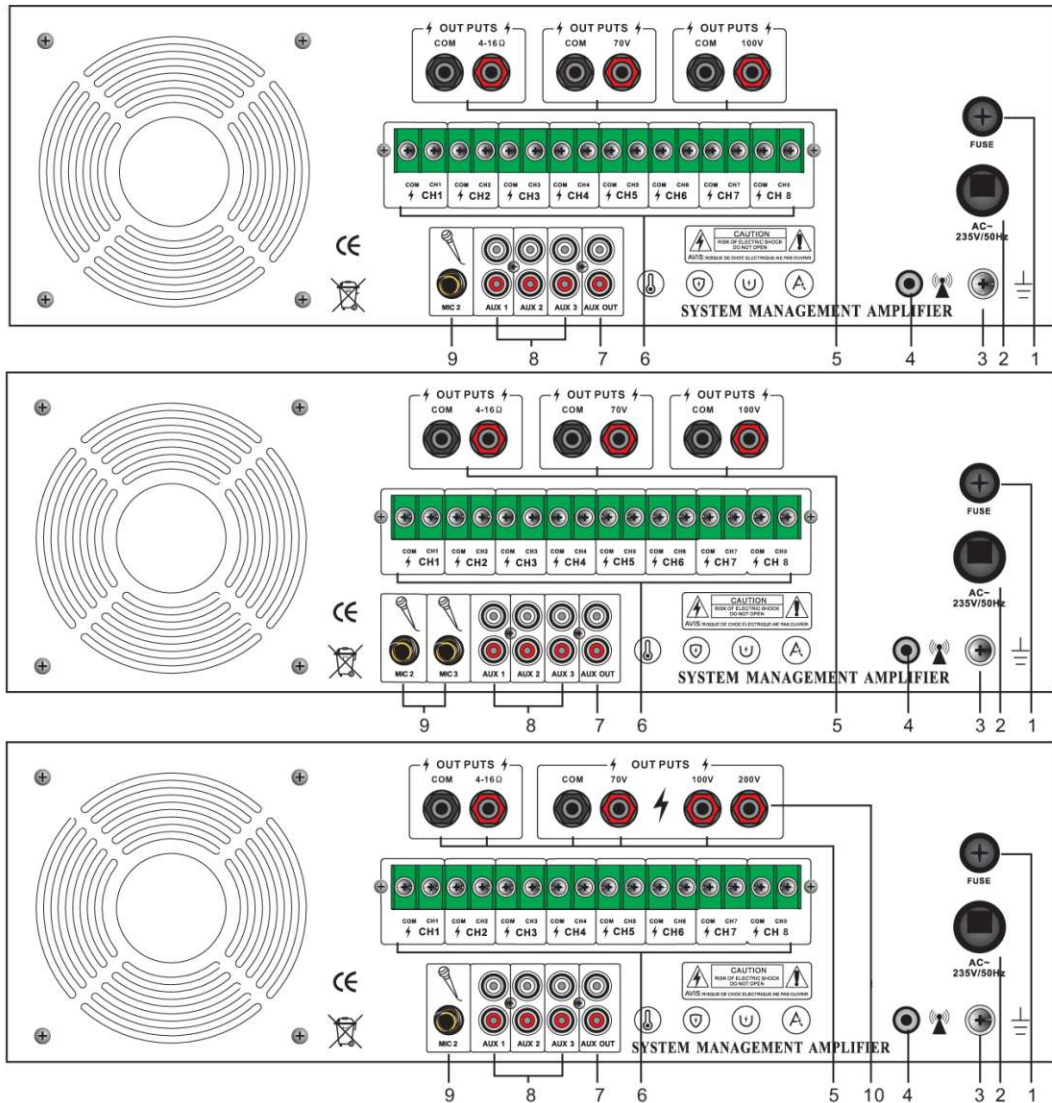

## INSTALLATIONS AND OPERATIONS

### Connection to the mains supply

Before connecting the amplifier to the mains socket, always make certain that:

1. The electric system and mains socket have an adequate grounding, compatible with the safety norms (if you're uncertain, consult specialized personnel);
2. The mains voltage corresponds to that shown on the rear of the unit (an allowance of up to +/-10% is accepted);
3. The on/off switch is in the OFF position.

Make sure the amplifier is also off before disconnecting the power cord from the mains socket.

### Switch on and off

In your reinforcement system, always switch on the amplifier after all the other equipment and always switch it off before anything else, if possible with the gain controls set at minimum: this will avoid annoying and sometimes dangerous signal peaks.

### Audio connections

Remember to always connect and disconnect other units with amplifier switch off.

Let the signals from sources as CD player, tape player and radio etc. into the input sockets via audio cable with shield. This unit can accept at the same time 2 stereo line inputs, adopt RCA connector. Link microphone you will need to microphone input (this unit has 2 microphone inputs, MIC1 is first with mute function located at the front panel, MIC2 are located at the rear panel, they are all TRS phone jacks).

Please use only professional low impedance microphone with output level at -35dB~-60dB

### Load connections

The power output mode of this series is stable voltage 100V (120V), this mode is usually used for public broadcasting, they are easy for load linking, less power consume and suitable for long distance transmission. Be careful to check the load impedance and load type to avoid damage of load or amplifier.

The load can be made up of many sound boxes which are stable voltage type with 120V input voltage, these sound boxes is usually linked in parallel, the total power of these parallel boxes should be less than the total output power of the unit, and have enough surplus.

The line output of the unit can be used for linking to another power amplifier.

### CHECK AND MEASURE FOR LOAD

The load must be checked and measured at the first time, because of long distance from the power amplifier to the load, because of load complicated connecting and section controlling. In the public broadcasting systems the bad cable using and mistaken connecting will always occur, such as load short circuit, load part short circuit and indirect short circuit between output cables of two amplifiers.

1. Measure the DC impedance of the end terminal of the load by multi-meter, you may determine roughly if the load has been short circuit.
2. Check when the unit is on

Turn left all potentiometer knobs at the front panel to the minimum position, then turn the source (as CD) on and let it output signal. Turn this unit power on, then rotate the corresponding level knob to 3 o'clock after the buzzer chirps several times and the relay acts. At this time you should feel the output power signal will be right level and excellent tone quality. You may observe the unit status and feel the wind from the vents, if the unit will not protect itself within one hour and also no too hot wind (above 50 C) from vents, and thus we think the load is good. If the unit immediately go into protection (the buzzer always chirps and no signal output) or the wind temperature rise quickly, it means a load trouble has occurred. You should put a current meter into the output load circuit to measure the output current. By comparing the output current with the rated output current as followed, you may determine the load status. You will use this power amplifier again after you getting rid of all load trouble.

### OPERATIONS

Rotate all knobs of the potentiometers at the front panel to full closed, turn the unit on, now the power indicator is on. After the buzzer chirps several times and the relay acts, turn right the knob of the corresponding potentiometer, you also can adjust the five-band equalizer and adjust the control of the total output level until the output level is just fit for you. Remember that you should reduce the input signal level when the last one of the level indicator is always on, if not, the unit will be overloading and the output power signal will be clipping.



# CONNECTIONS

## CONNECTIONS 1. Constant Resistance Output

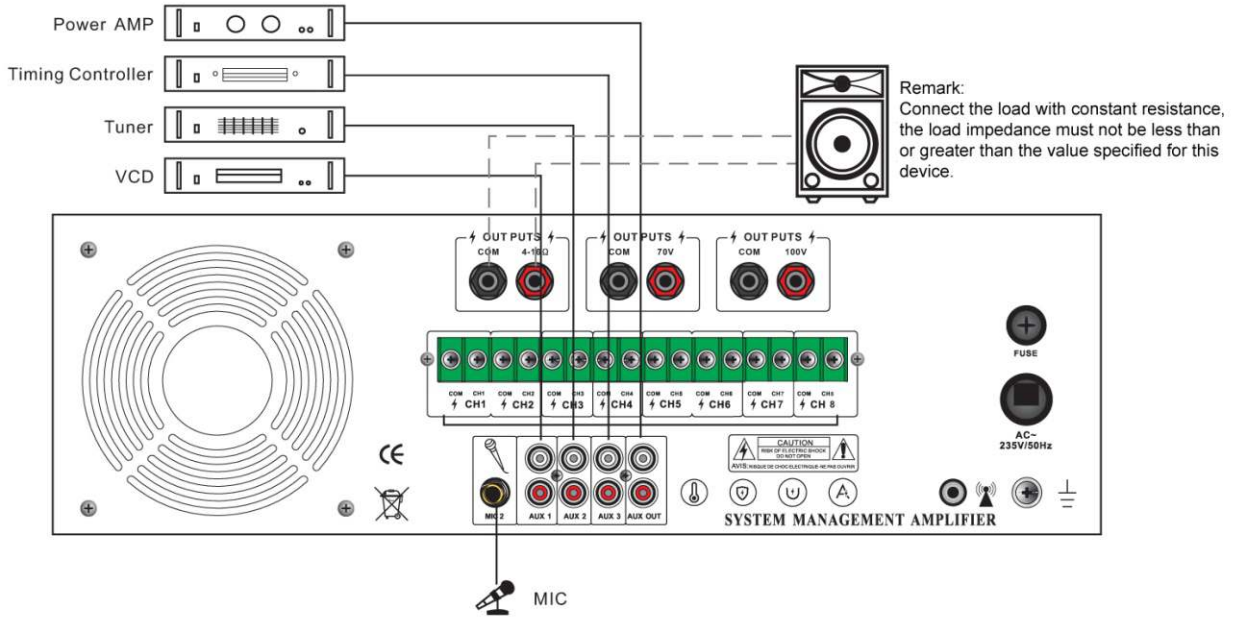

## CONNECTIONS 2. Constant Voltage Output

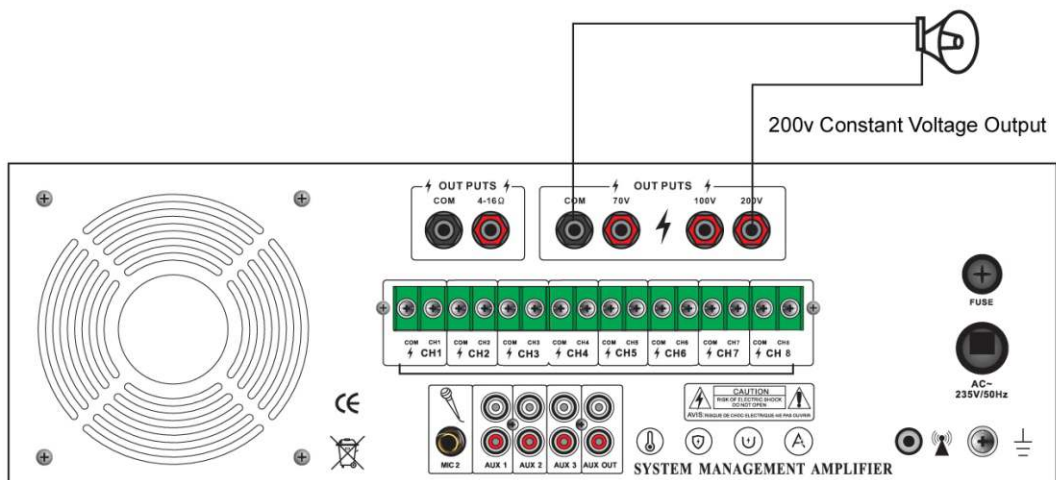

### 200V Constant Voltage Output Terminals

This sub output is used for connecting loudspeakers over long distances. It is not recommended for short distances, always check to match the impedance of your loudspeakers first.



# CONNECTIONS

## CONNECTIONS 3. Constant Voltage Output

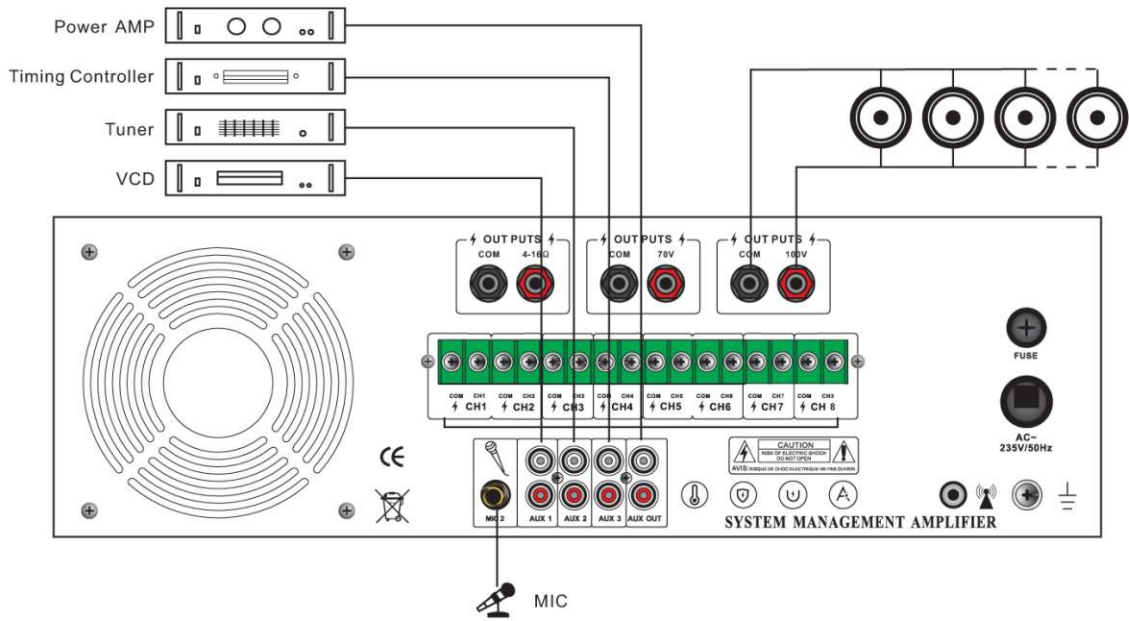

## CONNECTIONS 4. Partition Connection

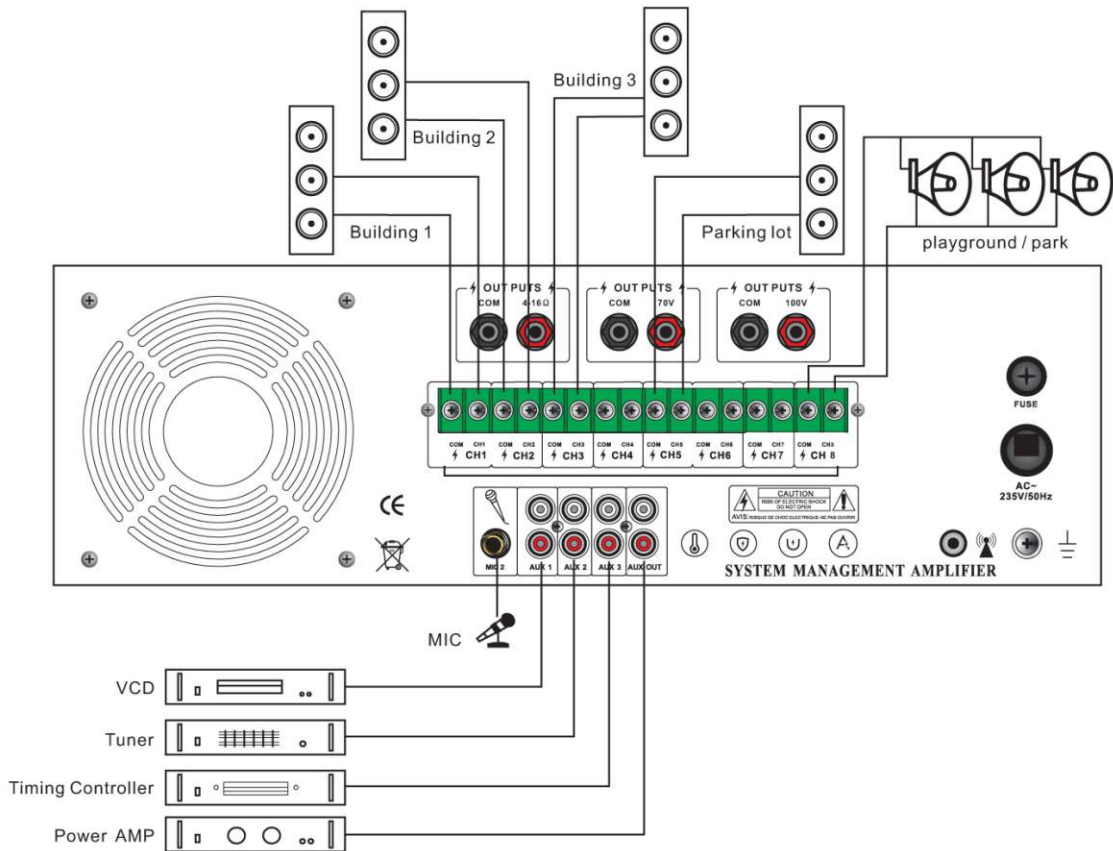

# TECHNICAL SPECIFICATION

## System Diagram

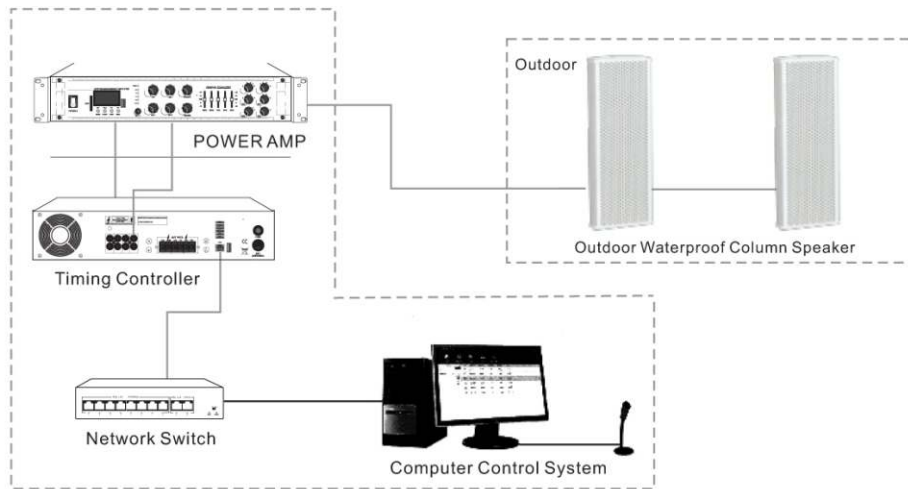

## SPECIFICATIONS

Parameter	Model	HZ-EQB(P)-800	HZ-EQB(P)-1000	HZ-EQB(P)-1500	HZ-EQB(P)-2000
		HZ-ECHOB(P)-800	HZ-ECHOB(P)-1000	HZ-ECHOB(P)-1500	HZ-ECHOB(P)-2000
Rated output power		800W	1000W	1500W	2000W
Output 1		4-16 ohms (Section 1)			
Output 2		70V (Section 2)			
Output 3		100V (Section 3)			200V
Output 4		100V (CH1-CH8)			
Five-band equalizer		250Hz, 500Hz, 1KHz, 4KHz, 8KHz +/- 12dB			
Frequency Response	Low-cut	130Hz ~22KHz +/-2dB			
	No low-cut	60Hz ~22KHz +/-2dB			
THD (1KHz)		≤0.5%			
S/N Ratio	MIC1~2	<-108dB Equivalent input noise			
	LINE1,3	>88dB			
Inputs	MIC1~2	-50dB 600ohms unbalanced			
	LINE1,3	-10dB 10Kohms unbalanced			
MIC1 mute adjust		-30dB			
Line(Record) output		0dB(-10dB) unbalanced at 600ohms load			
Power supply		AC 120V, 220V, 230V, 110V/220V, 50~60Hz. (Please refer to the nameplate on the rear panel.)			
Power consume		1200VA	1500VA	2500VA	3500VA
Net weights(Kg)		24.5 KG	25.5 KG	27.5 KG	29.8 KG
Dimensions(WDxH)		482x467x132mm			

The functions and related technical parameters described in this manual are terminated upon completion of the products and are subject to change without notice.

# Precautions for use

**In order to prevent damage, equipment damage or property damage to users and others, it is important to observe the following basic precautions.**



This logo represents a "forbidden" content



This logo represents the "must" content

Check whether the power cord is broken, do not pull the power cord to pull out the plug, should pull out the plug directly, otherwise cause electric shock. Short circuit or fire.

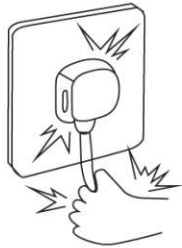

In the process of use, do not clog the vents, all vents must remain unblocked to avoid overheating.

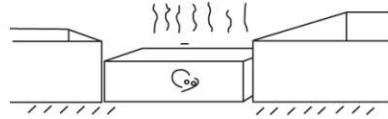

Do not place the equipment in a large amount of dust. Shake. Extreme cold or hot environment.

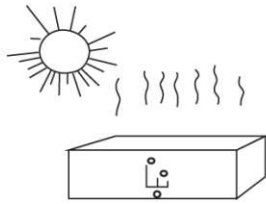

Do not place heavy objects on this equipment. Operation switch. Avoid excessive force when a button or link to an external audio source.

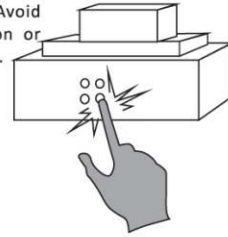

Avoid any foreign material (e.g. paper, metal, etc.) through the clearance or opening of the machine to enter the machine. If this happens, please disconnect the power immediately.

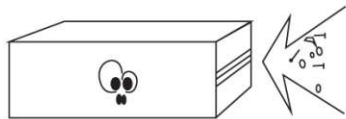

Please do not attempt to remove the internal parts of the equipment or make any modifications.

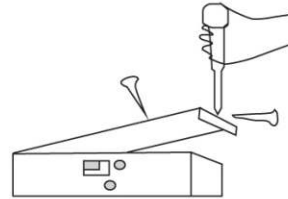

When the machine is in use, the sound is suddenly interrupted, or emit abnormal smell, or smoke, please remove the power plug immediately, lest cause electric shock. Fire and other accidents, and ask professional personnel to repair The equipment.

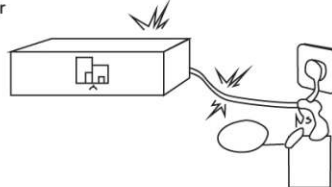

Do not use this equipment for a long time, please be sure to unplug ac power supply. Power cable or close wall outlet to achieve zero energy consumption.

